

# D02 gG 35A/400V



## Specifikacije

Šifra proizvoda	002212003
Opis	D02 gG 35A/400V
Težina	13
Nivo	Topljivi umetci (gG)
AC Prekidna moć	50
DC Prekidna moć	8
Karakteristika	gL/gG (cable protection/equipment protection)
Dimenzija	E18
Indikator	prednji
Grupa proizvoda	Niskonaponski topljivi umetci D0
Nazivni AC napon	400
Nazivna struja	35
Nazivni DC napon	250
Veličina	D02
Tip	D0

Web stranica proizvoda 

## Druga dokumentacija



CE izjava  
Tehnički podaci

# Karakteristike granične propuštene struje

Cut-off current characteristics

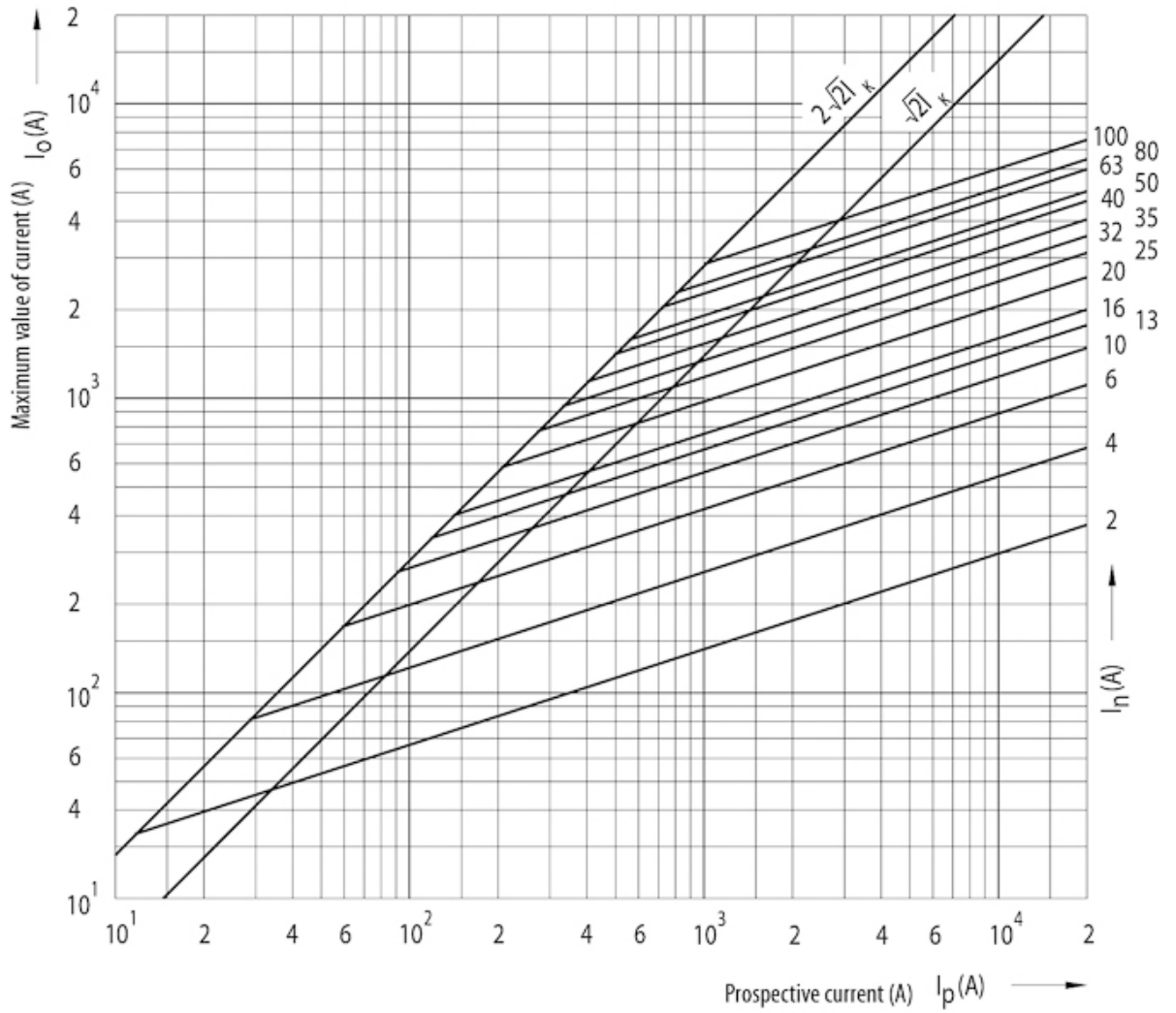

# Diagram I2t

Melting energy characteristics I<sup>2</sup>t

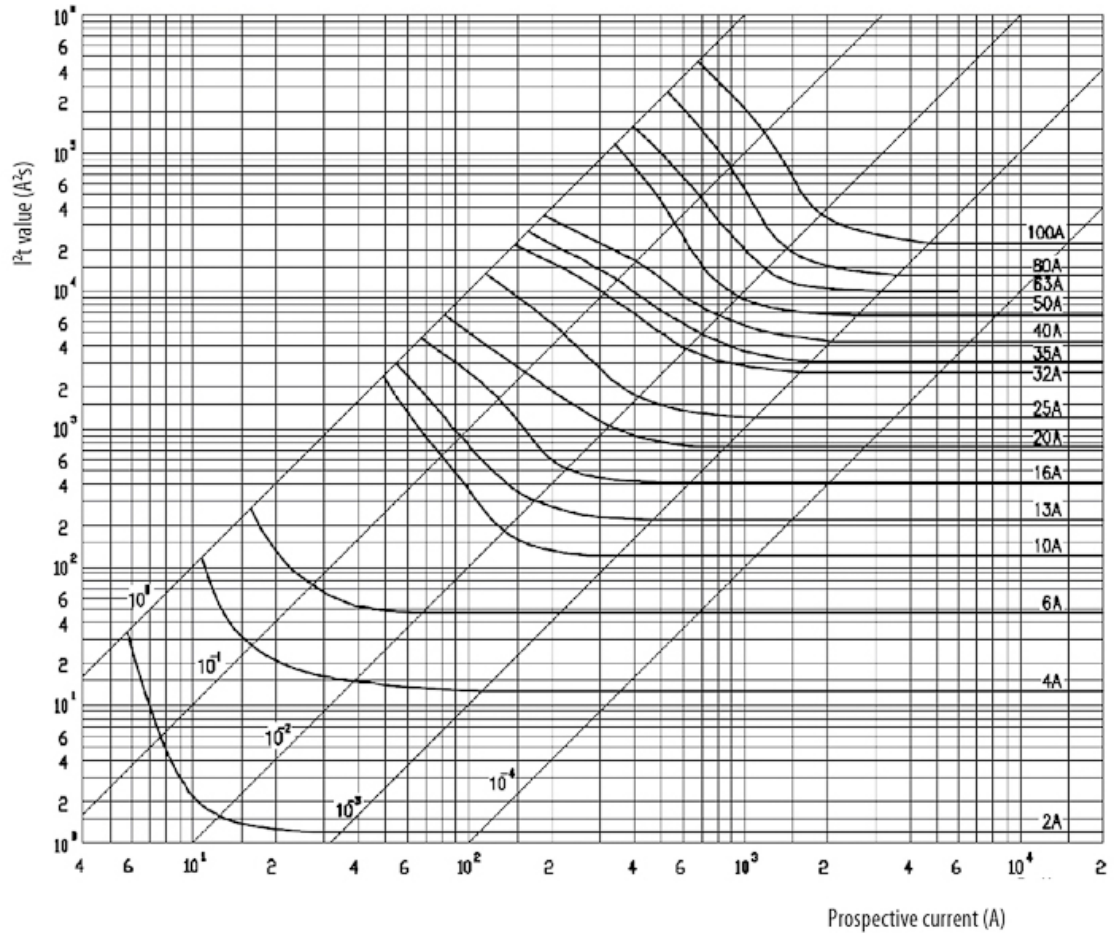

# Vremensko-strujna karakteristika I/t

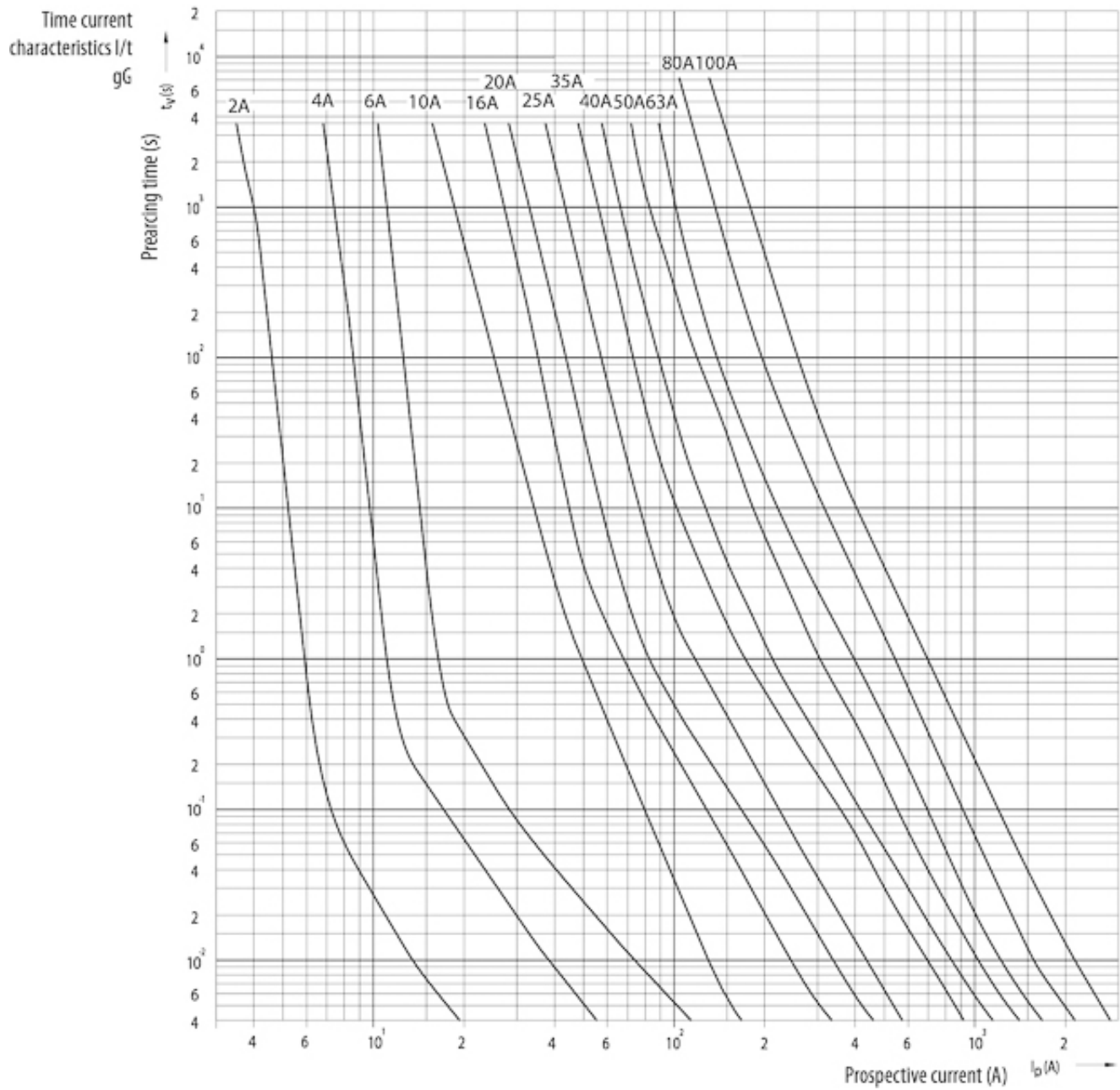

## Dimenzije

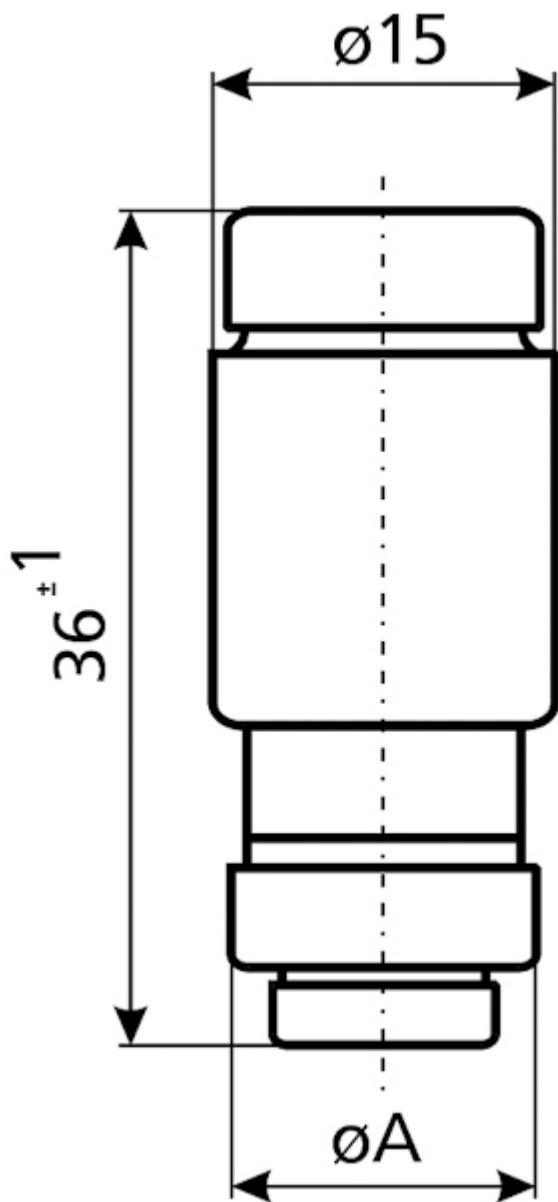

$l_n$ [A]	$\varnothing A$
20	10,9
25	12,1
32	13,3
35	13,3
40	13,3
50	14,5
63	15,9