



COMPACT Splicing Connectors; 2-conductor connector; with operating levers; Max.ambient operating temp. 85 °C

Item No.: 221-412



COMPACT Splicing Connectors; 2-conductor connector; with operating levers; Max.ambient operating temp. 85 °C

Marking

RoHS ✓
Compliant

Business data

Supplier	WAGO
Item no.	221-412
GTIN / EAN	4050821808435
Content	1
Order amount	100
Customer item number	

Notes

Technical data

Miscellaneous

Safety information 1	In grounded power lines
Ratings per	EN 60664
Rated voltage (II / 2) [V]	450 [V]
Rated impulse voltage (II / 2) [kV]	4 [kV]
Rated current [A]	32 [A]
Legend (ratings)	(II / 2) Overvoltage category II / Pollution degree 2

Technical data	
<i>Connection technology</i>	<i>CAGE CLAMP®</i>
<i>Actuation type</i>	<i>Lever</i>
<i>Connectable conductor materials</i>	<i>Copper</i>
<i>Nominal cross section</i>	<i>4 mm²</i>
<i>Solid conductor</i>	<i>0.2 ... 4 mm² / 24 ... 12 AWG</i>
<i>Stranded conductor</i>	<i>0.2 ... 4 mm² / 24 ... 12 AWG</i>
<i>Fine-stranded conductor</i>	<i>0.14 ... 4 mm² / 24 ... 12 AWG</i>
<i>Strip length</i>	<i>11 mm / 0.43 Inch</i>
<i>Total number of connection points</i>	<i>2</i>
<i>Total number of potentials</i>	<i>1</i>
<i>Type of wiring</i>	<i>Side-entry wiring</i>
<i>Width</i>	<i>13.1 mm / 0.516 Inch</i>
<i>Height</i>	<i>8.3 mm / 0.327 Inch</i>
<i>Depth</i>	<i>18.6 mm / 0.732 Inch</i>
<i>Color</i>	<i>transparent</i>
<i>Flammability class per UL94</i>	<i>V2</i>
<i>Weight [g]</i>	<i>1.6 [g]</i>
<i>Surrounding air temperature (operation)</i>	<i>85 °C</i>
<i>Continuous operating temperature up to [°C]</i>	<i>105 [°C]</i>
<i>T-Marking per EN 60998</i>	<i>T85</i>
<i>Packaging type</i>	<i>BOX</i>
<i>Main product function</i>	<i>Lever terminal block</i>
<i>Product type</i>	<i>Splicing connectors</i>

Images & drawings



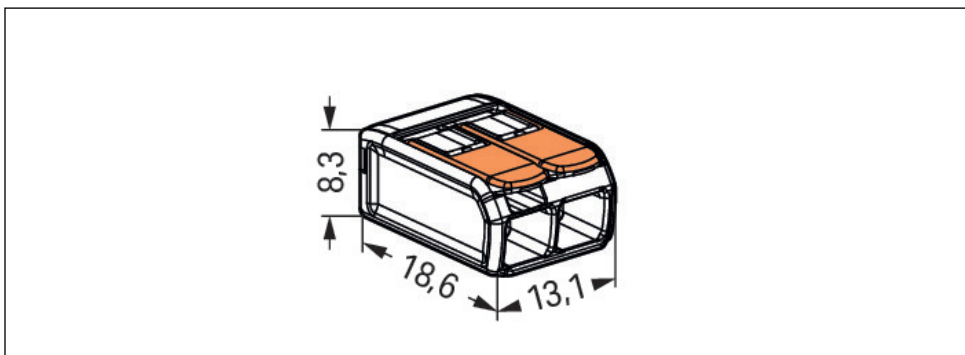



Address

WAGO Kontakttechnik GmbH & Co. KG

Hansastr. 27

32423 Minden

Telefon: 0571/887-0

Fax: 0571/887-169

<http://www.wago.com>

© WAGO Kontakttechnik GmbH & Co. KG

Technische Änderungen und Irrtümer vorbehalten.